



make your
RESTROOM
the BEST ROOM

your **INDUSTRY** LEADER

Hiny Hiders Partitions – Color: Grey, Texture: Orange Peel
Configuration: Floor Mounted Overhead Braced, Height: 55” Standard Panels & Doors
Vanities, Urinal Screens, Tufftec Benches – Color: Grey
Tufftec Lockers – Color: Blueberry

With over **25 years of experience**, Scranton Products is the industry leader in plastic bathroom partitions and lockers. Constructed from **premium, American-made solid plastic**, our products resist dents, scratches, corrosion, graffiti and mildew.

When you purchase Scranton Products, you are **investing in peace of mind**. With unmatched durability and an array of designer colors and textures, Scranton Products installs confidence in every product.

INNOVATIVE SOLUTIONS FOR A BETTER FUTURE

FAMILY

OF PRODUCTS



ARIA PARTITIONS™
EXPECT MORE



ECLIPSE PARTITIONS™
PRIVACY BY DESIGN



HINY HIDERS®
STYLE THAT LASTS AND LASTS



TUFFTEC LOCKERS.
LOCKER SOLUTIONS FOR EVERY PLACE & PURPOSE

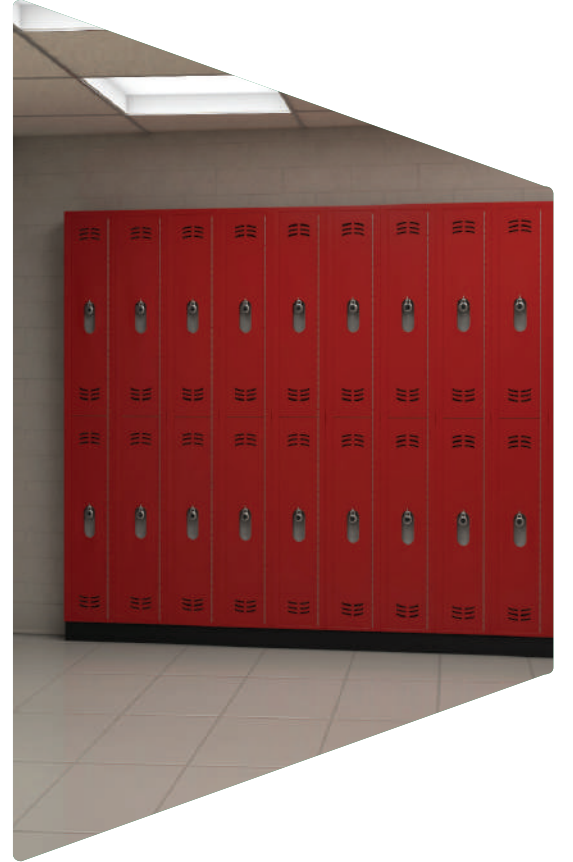

DURALIFE LOCKERS™
BUILT FOR THE LONG HALL

VANITIES



URINAL SCREENS



SHOWER DIVIDERS



DRESSING COMPARTMENTS



BENCHES



SCRANTON PRODUCTS

www.scrantonproducts.com

why PERFORMANCE PLASTICS

Commercial bathroom partitions are placed in harsh, high traffic environments that tend to be damp, making the materials susceptible to mold, mildew and rust. It is also common to encounter graffiti and vandalism in these public spaces.

It is important to invest in a worry-free product that will save you time and money.

Solid plastic partitions are built to last, down to every detail. Graffiti can be easily wiped clean with a common non-abrasive cleaner, and since Scranton Products performance plastic is formulated with a solid color throughout, scratches are difficult to see. Compared to other traditional material types, performance plastic has a greater resistance to impacts and dents providing you with a low maintenance restroom that will look great for years.



Eclipse Partitions - Color: French Blue, Texture: Orange Peel
Configuration: Floor Mounted Overhead Braced, Height: 72"

IMPACT AND DENT RESISTANCE TEST RESULTS

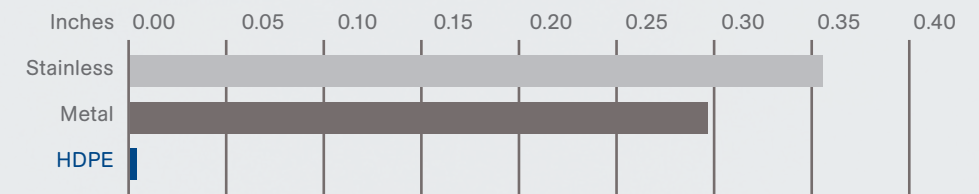

Depth of Impact

An impact test conducted following ASTM standards showed that Scranton Products performance plastic has 59 times greater resistance to impact when compared to metal.

Patent Pending

NO PAINTING

Scranton Products partitions are solid color throughout and will never require painting.

EASY GRAFFITI REMOVAL

Graffiti can be easily wiped clean with a common, non-abrasive cleaner.

CLEANER, HEALTHIER RESTROOMS

Impermeable to moisture, solid plastic's non-porous surface does not support the growth of mold and mildew and will never rust.

NATURALLY GERM RESISTANT

Scranton Products performance plastic partitions are naturally resistant to common bacteria including MRSA. Testing has shown that after 24 hours, 98.4% of MRSA died off the surface of solid plastic without the use of cleaning solutions or antimicrobial additives. What's more, Scranton Products partitions are fully power washable and steam cleanable.

expect
MORE

Aria Partitions
Color/Texture: White & Black, Orange Peel, Trim: Standard, Door Style: Traditional 1000

Aria Partitions will provide the **ultimate in privacy** and design allowing you to **EXPECT MORE** when choosing a commercial restroom partition.



**ARIA
PARTITIONS™**

FEATURES

- Ultimate privacy design
- Customizable
- Unsurpassed durability
- Sustainable
- Cleaner, healthier restrooms

Patent Pending

expect more out of **RESTROOM** DESIGN



Aria Partitions
Color/Texture: Mahogany, Orange Peel, Trim: Fluted, Door Style: Traditional 2600



ARIA PARTITIONS

Bring your restroom experience to life. Aria Partitions offers **millions of design combinations** to choose from and will provide you with the **ultimate privacy experience**.

Patent Pending

DOOR DESIGN OPTIONS

17 unique door designs ranging from Classic to Exclusive.

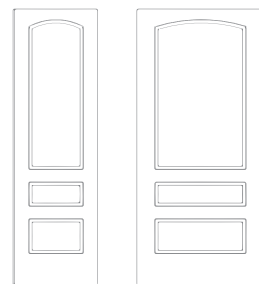

SHIPLAP EDGE

Creates an overlap, eliminating vertical sight lines for increased privacy.

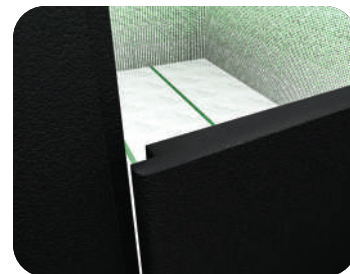

FULL HEIGHT COMPARTMENT

Optional full height compartment to provide the ultimate privacy.

86" Minimum

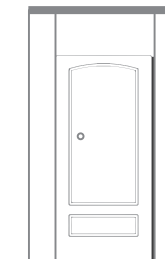

112" Maximum

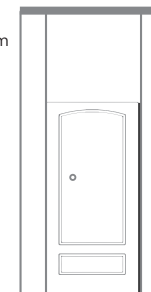

PANEL DESIGN OPTIONS

7 panel designs to fully customize your restroom.



DOOR & PANEL DESIGNS

Patent Pending

Patent Pending

TRADITIONAL DOOR SERIES



MODERN DOOR COLLECTION

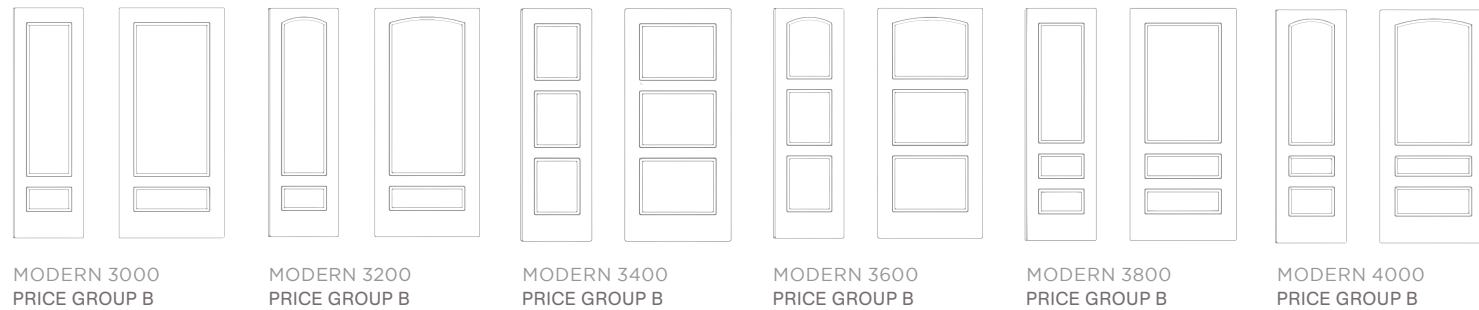

EXCLUSIVE DOOR COLLECTION

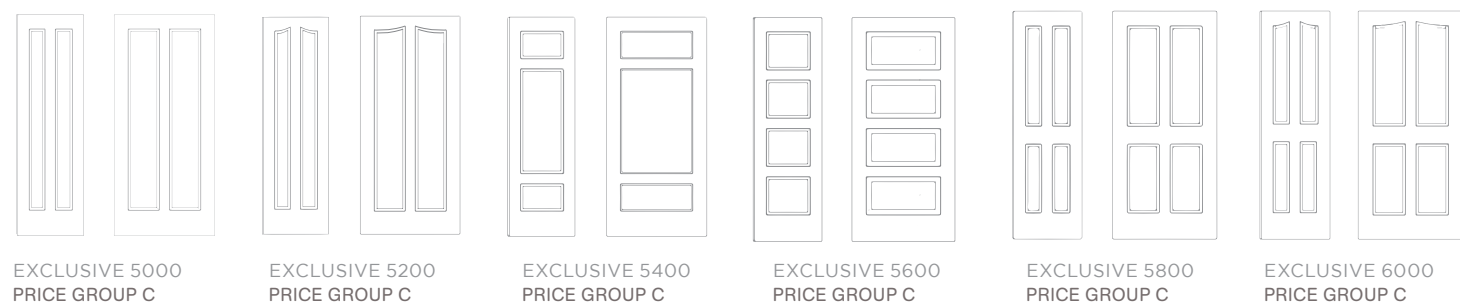

**Illustrations represent 24" and 36" wide doors to show pattern changes.*

SIDE PANEL OPTIONS

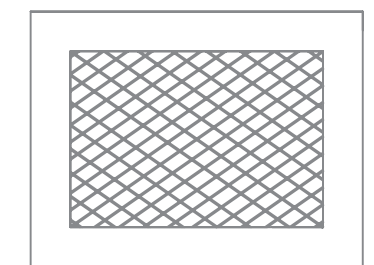
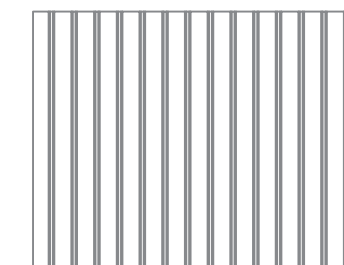
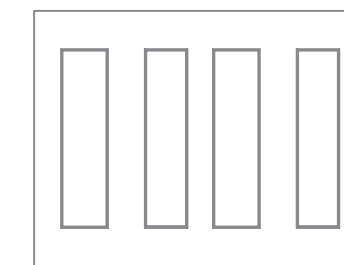
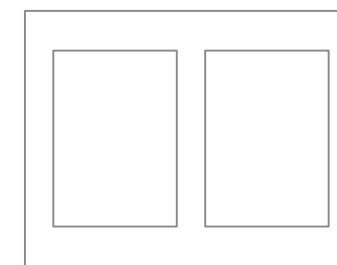

COLOR, TEXTURE & DESIGN

OPTIONS



TRADITIONAL COLOR COLLECTION



BOLD COLOR COLLECTION

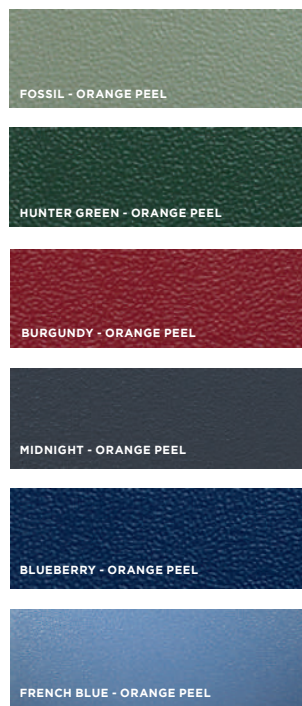

WARM COLOR COLLECTION

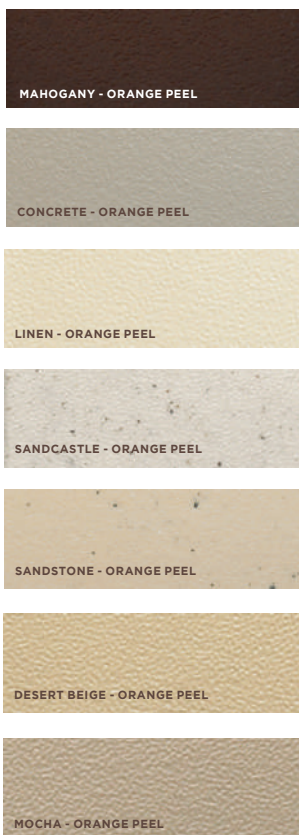

METALLIC COLOR COLLECTION

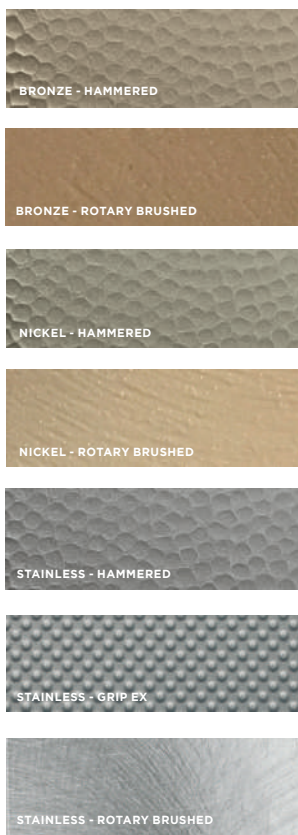

TRIM COLOR

Sold in 96" lengths except as noted.



*84" Lengths

H = Hammered Texture
RB = Rotary Brushed Texture
All others in Orange Peel texture

TRIM CHOICES

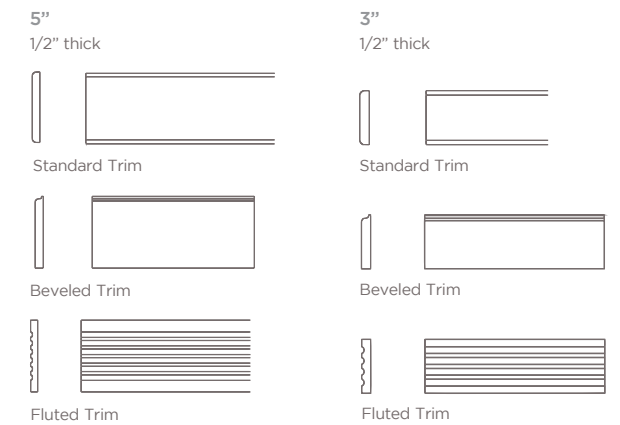

HARDWARE

BRACKETS

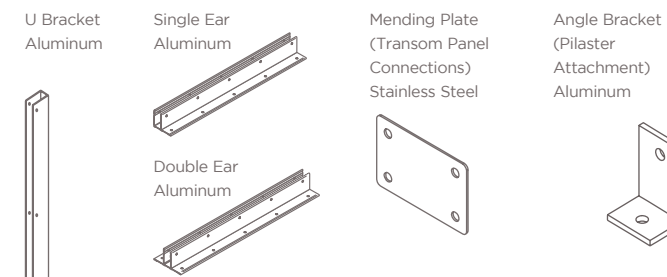

HINGES

Edge Mounted
Continuous
Stainless Steel
Hinge



DOOR ACCESSORIES

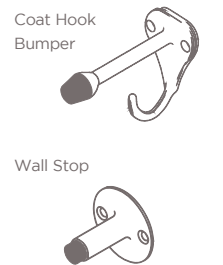

HEADRAIL

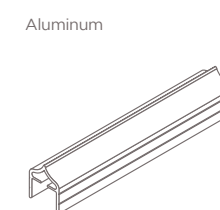

LATCH



HEIGHT OPTIONS

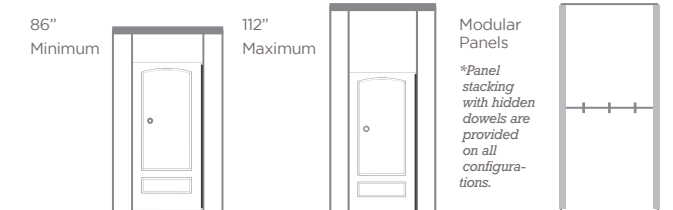

CUSTOM COLORS AVAILABLE UPON REQUEST.

Color matching is limited by printing process. Actual samples are available and recommended prior to color selections.

*Special orders require extended lead times. Minimum order requirements may apply.

FIRE RATING

Whether your fire rating needs are NFPA 286, Class A, or Class B, we have the material to match.

privacy by **DESIGN**

Eclipse Partitions – Color: White, Texture: Orange Peel
Configuration: Floor Mounted Overhead Braced, Height: 62" High Panels & Doors

Eclipse Partitions are the future of restroom partitions that offer both **innovative design aesthetics** and **durable performance**.

The clean lines of this system provide a **contemporary look** to any bathroom décor. The high privacy design delivers **enhanced privacy** above traditional partitions.



ECLIPSE
PARTITIONS™

FEATURES

- High privacy design
- Innovative hinge & post design structure
- Contemporary anti-grip head rail
- Durable solid performance plastic material

next GENERATION OF PARTITIONS



Eclipse Partitions – Color: Sandstone, Texture: Orange Peel
Configuration: Floor Mounted Overhead Braced, Height: 62" High Panels & Doors

ECLIPSE PARTITIONS
Combining **innovative aesthetics** with **durable performance**, Eclipse Partitions' **minimum sight design** offers advanced privacy. The contemporary look and extensive color and texture collections are sure to **enhance your facility décor**.

INNOVATIVE HINGE
The new edge-mounted continuous stainless steel hinge provides a no sight and sleek aesthetic to your restroom design.

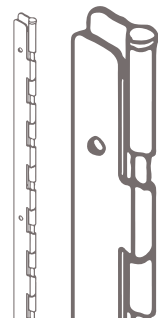

SHIPLAP EDGE
Creates an overlap, eliminating vertical sight lines for increased privacy.

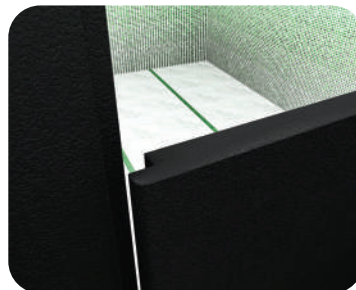

Example of shiplap

CLEAN EXTERIOR AESTHETICS
Designed with minimal exterior hardware visible on the outside of the stalls.



HEIGHT OPTIONS
55" standard, *62" high, and *72" extra high doors and panels.

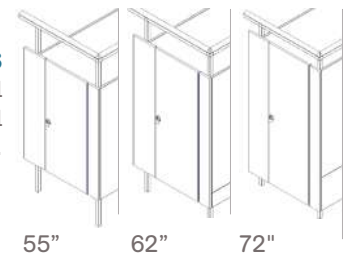

*Modular panel may be required if stall depth is greater than 55".

COLOR, TEXTURE & DESIGN

OPTIONS



TRADITIONAL COLOR COLLECTION



BOLD COLOR COLLECTION

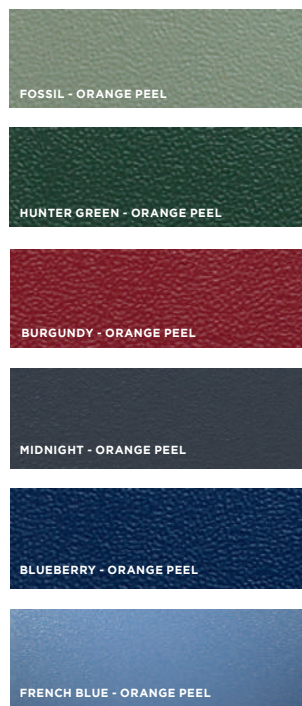

WARM COLOR COLLECTION



METALLIC COLOR COLLECTION

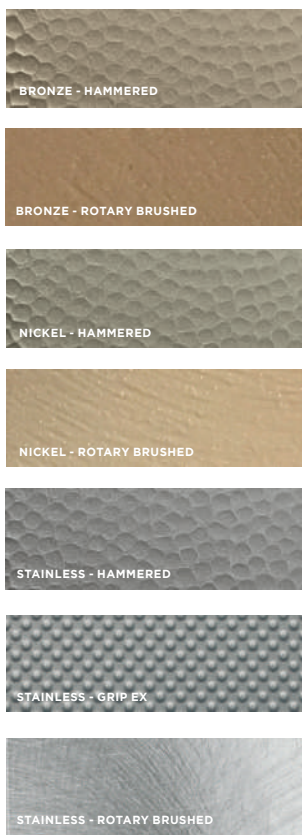

DESIGN OPTIONS

BRACKETS

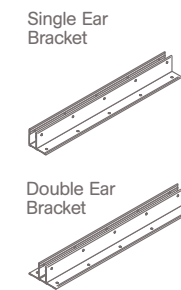

HINGES

Edge-Mounted
Stainless Steel
Continuous Hinge



STANCHION

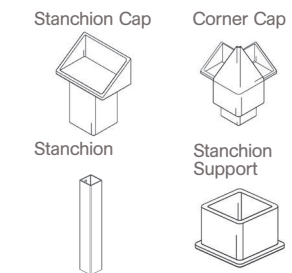

HEAD RAIL

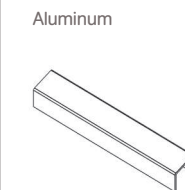

LATCH



HEIGHT OPTIONS

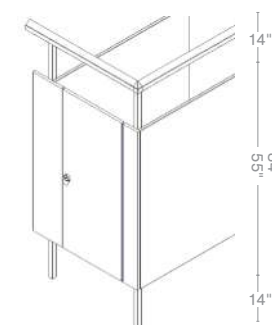

55" Standard



62" High*

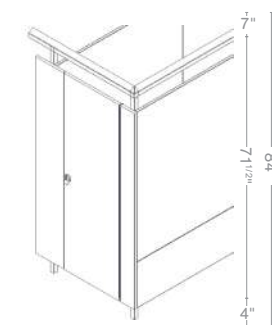

72" Extra High*

CONFIGURATION OPTIONS

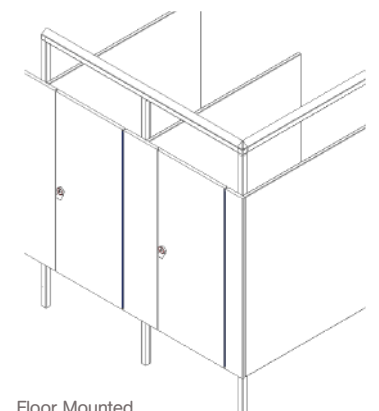

Floor Mounted
Overhead Braced

CUSTOM COLORS AVAILABLE UPON REQUEST.

Color matching is limited by printing process. Actual samples are available and recommended prior to color selections.

*Special orders require extended lead times. Minimum order requirements may apply.

*Modular panel may be required if stall depth is greater than 55".

Modular Panels

*Panel stacking with hidden dowels are provided on all configurations



FIRE RATING

Whether your fire rating needs are NFPA 286, Class A, or Class B, we have the material to match.

style that **LASTS** AND LASTS

Hiny Hiders Partitions – Color: Black, Texture: Orange Peel, Hardware: Continuous Aluminum Hinge & Strike
Configuration: Floor Mounted Overhead Braced, Height 72” Extra High Panels & Doors

With **tough construction** and **rugged good looks**, Hiny Hiders Partitions offer durability that will save customers time, hassle, and maintenance costs. Hiny Hiders Partitions offer **superior value** that simply can't be beat by the competition.



FEATURES

- Durable solid performance plastic material
- Solid classic construction
- Multiple hardware options
- Numerous design configurations
- High privacy options

the CLASSIC CONSTRUCTION



Hiny Hiders Partitions – Color: Black, Texture: Orange Peel, Configuration: Floor Mounted Overhead Braced, Height: 55", Door Engraving: Traditional 2600

FLOOR MOUNTED OVERHEAD BRACED

This classic style provides the most economical solution for high traffic areas where durability is a top priority. Easy installation in new construction or existing buildings makes this a versatile style option.

SIGNATURE DOOR & SIDE PANEL ENGRAVING

Scranton Products introduces a signature door collection to our Hiny Hiders Partitions. The same tough construction combined with 6 new door designs to enhance your traditional commercial restroom design.

SIGNATURE ENGRAVING OPTIONS



fast
EASY
 MAINTENANCE

Hiny Hiders Partitions - Color: Bronze, Texture: Hammered, Hardware: Regal Hinge
 Configuration: Ceiling Hung, Height: 55" Standard Panels & Doors



CEILING HUNG

This style offers an area free from obstruction to allow for fast and easy maintenance. The system requires structural supports in the ceiling for maximum rigidity.

120" Maximum Ceiling Height.

REGAL HINGE

This hinge provides a modern, bold design element and is perfect for adding a uniquely handsome and upscale finish to your bathroom stall.



HAMMERED TEXTURE

This texture creates a bold dimension to any color and stands out when paired with our metallic color collection.



adds **SUPERIOR** STRENGTH



Hiny Hiders Partitions – Color: Mahogany, Texture: Orange Peel, Hardware: Stealth Integral Hinge
Configuration: Floor To Ceiling, Height: 55" Standard Panels & Doors

FLOOR TO CEILING
This style provides an extra measure of stability in restrooms.
Maximum rigidity is achieved when structural supports are present in the ceiling.
120" Maximum Ceiling Height.

STEALTH INTEGRAL HINGE
This hinge is a perfect hardware match for a space seeking a minimal design aesthetic.



ORANGE PEEL TEXTURE
This texture pairs great with any color choice and will compliment any environment.



COLOR, TEXTURE & DESIGN OPTIONS

TRADITIONAL COLOR COLLECTION



BOLD COLOR COLLECTION

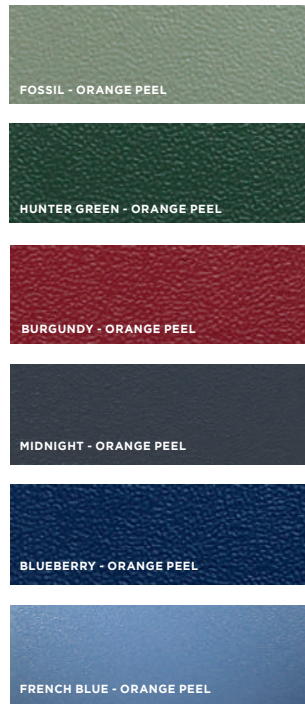

WARM COLOR COLLECTION



METALLIC COLOR COLLECTION

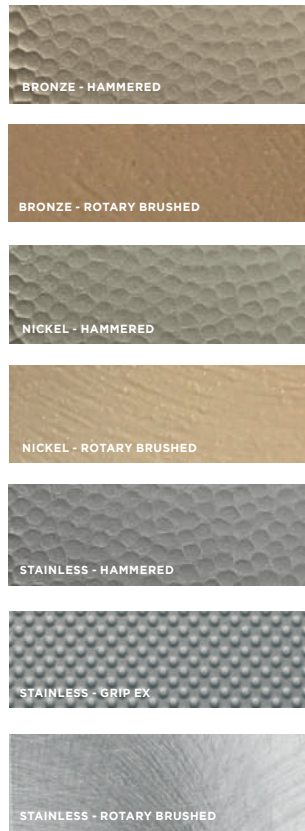

DESIGN OPTIONS

STIRRUP BRACKETS

Aluminum or Stainless Steel

HINGES

8" Wrap Around, 54", 65", 71" Continuous Aluminum, Regal Hinge, Vault Hinge, 54", 71" Continuous Stainless Steel Helix, 54" Continuous Stainless Steel Spring Loaded, Stealth Integral Hinge

HEAD RAIL

Aluminum

STRIKES

6", 54", 65", 71" Aluminum, 3" Stainless Steel Emergency Access

CONTINUOUS BRACKETS

54" Plastic, Stainless Steel or Aluminum, 68" Aluminum Only

LATCHES

Aluminum or Stainless Steel, Occupancy Indicator, Slider Latch

Pairs with Regal Hinge

SHOES

Plastic **, Stainless Steel

†† Limited colors available.

HEIGHT OPTIONS

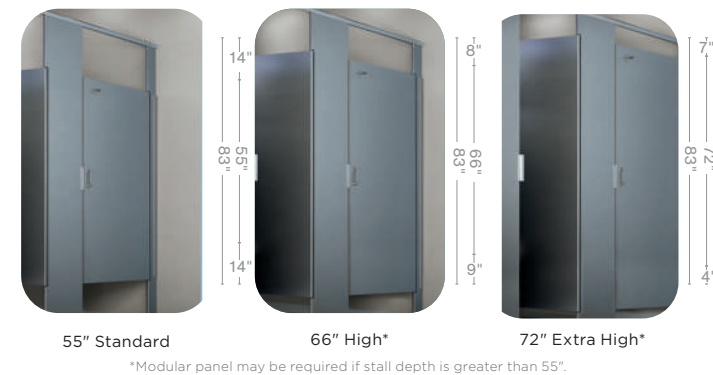

SIGNATURE DOOR PANEL ENGRAVING OPTIONS

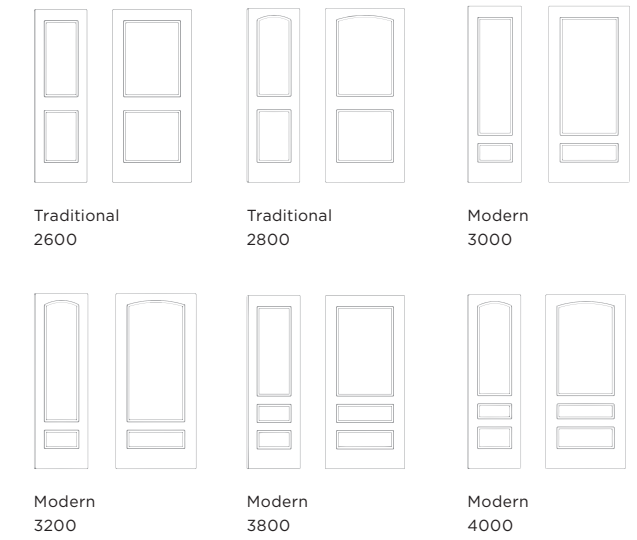

CONFIGURATION OPTIONS



FIRE RATING
Whether your fire rating needs are NFPA 286, Class A, or Class B, we have the material to match.

CUSTOM COLORS AVAILABLE UPON REQUEST.
Color matching is limited by printing process. Actual samples are available and recommended prior to color selections.
**Special orders require extended lead times. Minimum order requirements may apply.*

ADDITIONAL PRODUCT OFFERINGS



URINAL SCREENS

Our urinal screens are designed to withstand use and abuse in public restrooms. Scranton Products solid performance plastic materials clean easily, making them the ideal option. Our privacy and urinal screens are available in four easy to maintain mounting configurations.

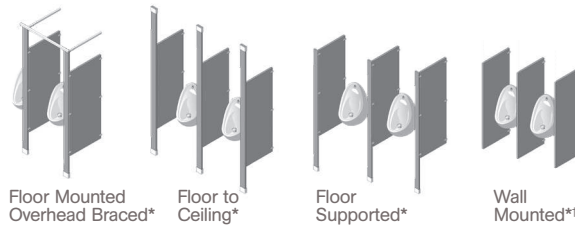

*Hiny Hiders †Eclipse

VANITIES

Scranton Products solid plastic vanity tops combine durability with long-lasting good looks. Offered in a wide variety of colors, our vanities provide an opportunity for you to match your partitions and compliment your overall design.

Our vanity tops have no absorption of water and resist mold, mildew and odors. They are easy to clean and resist soap stains, making them the ideal addition to your bathroom and will provide many years of worry-free performance.



SHOWER DIVIDERS

Scranton Products manufactures shower cubicles that are designed to perform in public shower areas. Solid plastic has no absorption of water and resists mold, mildew and odors. It is easy to clean and resists soap stains, making it the ideal material for your shower application.

Our shower cubicles feature an integrated head rail designed to accommodate optional curtain hooks and curtains*, eliminating the need for additional curtain rods.

*PVC-free shower curtain



DRESSING COMPARTMENTS

Our dressing compartments come in a wide variety of colors and textures providing many design options to compliment your décor. Scranton Products performance plastic resists dents, scratches, corrosion and graffiti which means customers save time, hassle and maintenance costs.

Our dressing compartments feature an integrated head rail designed to accommodate optional curtain hooks and curtains* eliminating the need for additional curtain rods.

*PVC-free shower curtain

SUPPORTING A **HEALTHIER** ENVIRONMENT



EASY ON THE ENVIRONMENT

As an industry leader in responsible recycling, Scranton Products is committed to reducing industrial waste. Scranton Products reclaims all of its scrap and recycles it into production to create new products and it is also offered in a 100% post consumer product. Incorporating our solid HDPE plastic products can contribute points toward LEED certification.

- MADE FROM RECYCLED MATERIALS
- IMPROVED AIR QUALITY
- NO PAINTING MEANS NO VOC EMISSIONS
- CONTAINS 25-100% POST INDUSTRIAL RECYCLED HDPE
- GREENGUARD GOLD CERTIFIED
- AVAILABLE WITH POST CONSUMER CONTENT
- 100% RECYCLABLE
- RESISTS MOLD, MILDEW & FUNGUS
- FACTORY RESPONSIBLE RECYCLING

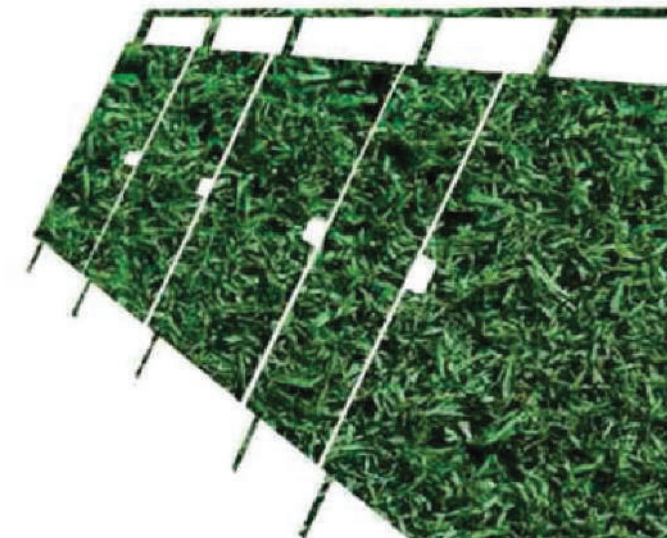

**WE DON'T JUST TALK TOUGH.
WE BACK IT UP.**

Proudly made in the USA,
Scranton Products' brands provide
industry leading protection.
We are so confident that our plastic
partitions will stand the test of time
that they are backed with a full
25-year warranty covering breakage,
corrosion and delamination under
normal conditions.

BATHROOM PARTITIONS
LOCKERS
LOCKER ROOM BENCHES
SHOWER DIVIDERS
DRESSING COMPARTMENTS
VANITIES



801 E. Corey Street
Scranton, PA 18505
800.445.5148
info@scrantonproducts.com
www.scrantonproducts.com

Patent Pending

